

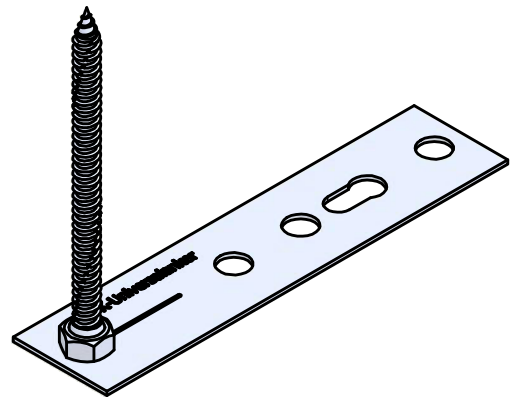

Ø7,5x112 drehbar gelagert

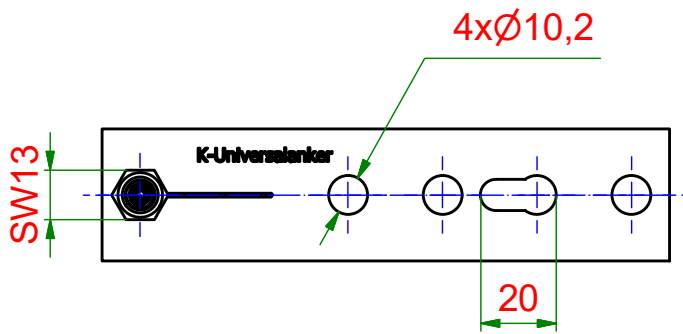
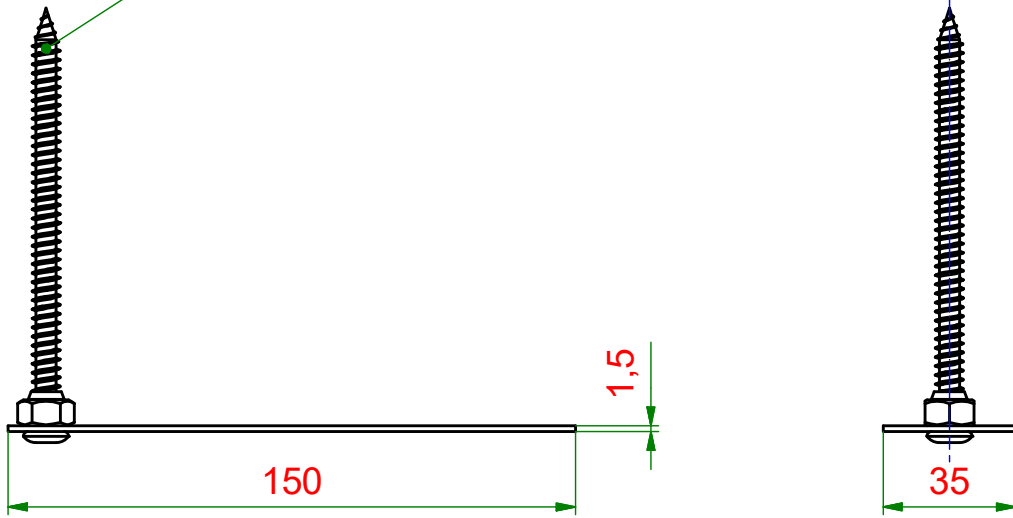
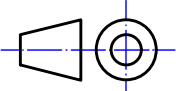

 Entwicklung und Herstellung		Material: verzinkter Stahl			
		Maßstab: 1 : 2	Masse: 0,09 kg		
Knelsen GmbH Am Schlinge 26 33154 Salzkotten Tel.: 05258 / 93766-95 Fax: 05258 / 93766-97 www.knelsen.de info@knelsen.de	Datum	Name	Titel, Beschreibung		
	Erstellt	14.03.2023	R.Heiermeier	FMS-150x1,5-F-7,5x112	
	Genehmigt			FMS-Anker - Flach-Profil	
	Allgemeintoleranzen nach ISO 2768-m			Bauteilnummer / Zeichnungsnummer	Blatt 1
	Schutzvermerk nach DIN ISO 16016 beachten			14909570	A4
			Revision:		